

- LEGENDA:
- C.C.A.
 - LASTRE DI MARMO
 - LATERIZIO FACCIA VISTA
 - SOTTOFONDO

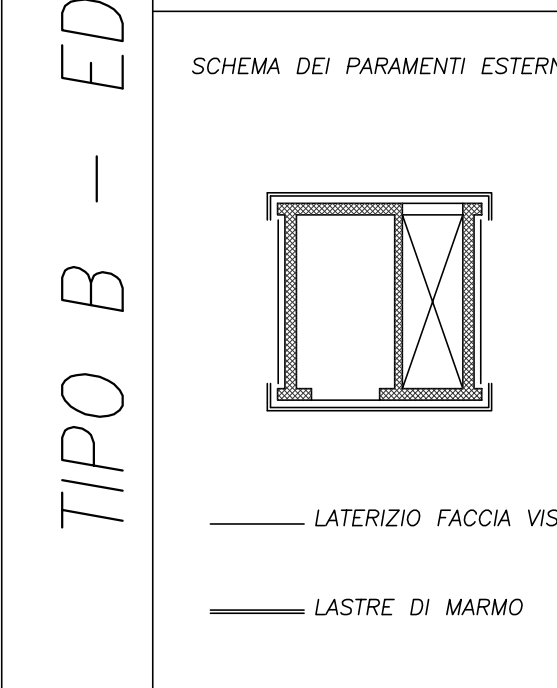

- LEGENDA:
- C.C.A.
 - LASTRE DI MARMO
 - LATERIZIO FACCIA VISTA
 - SOTTOFONDO

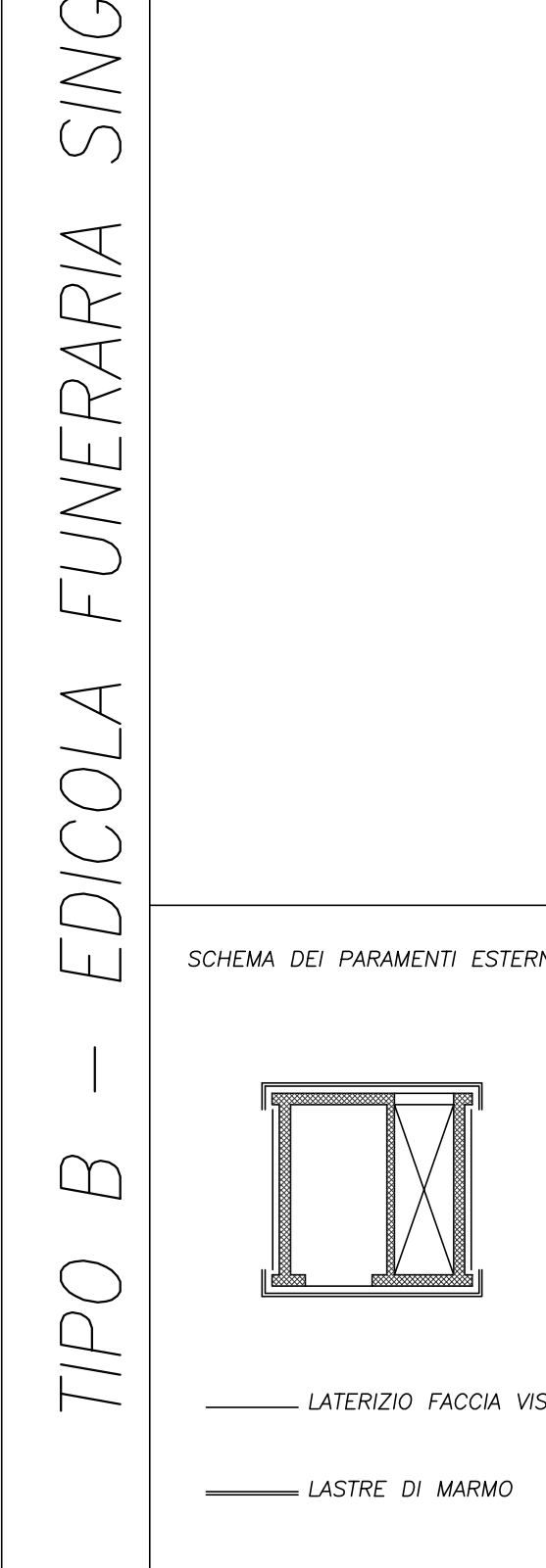
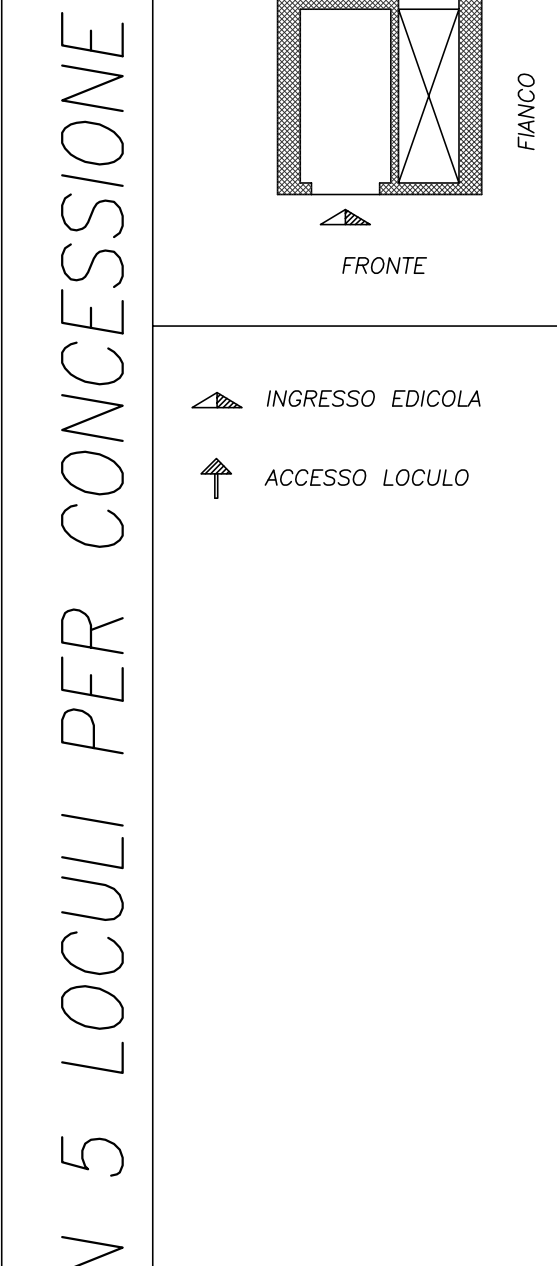
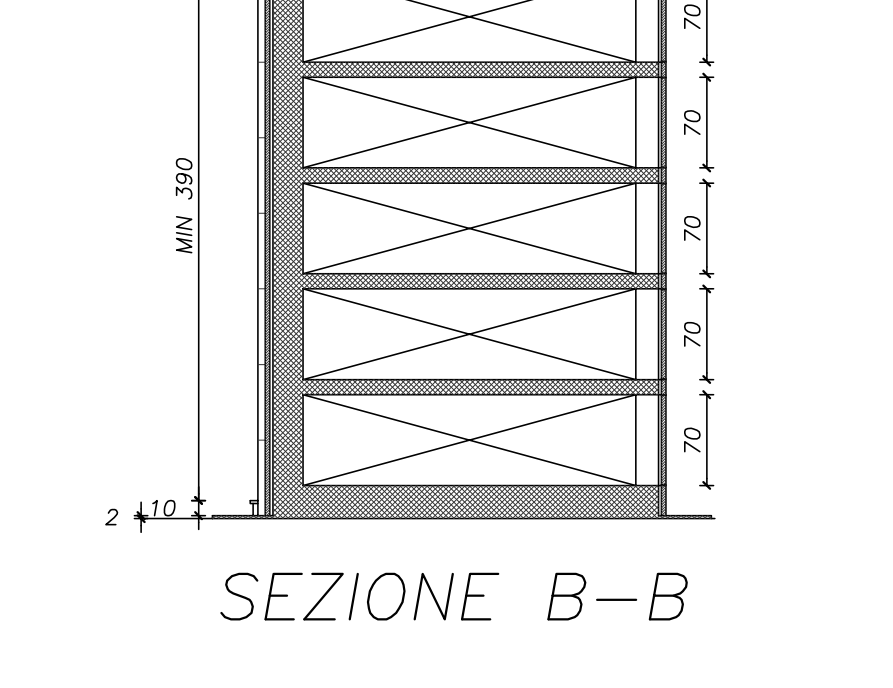
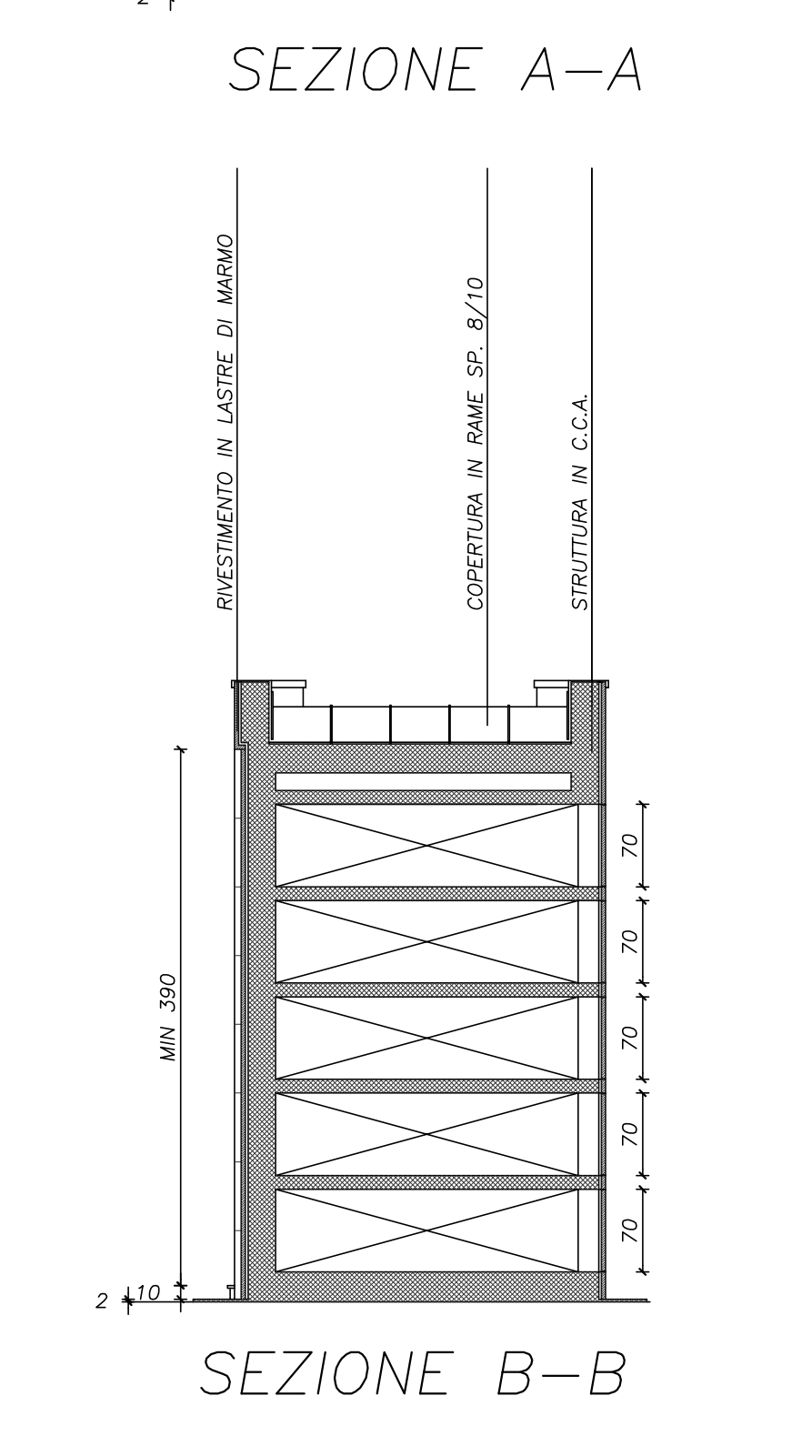
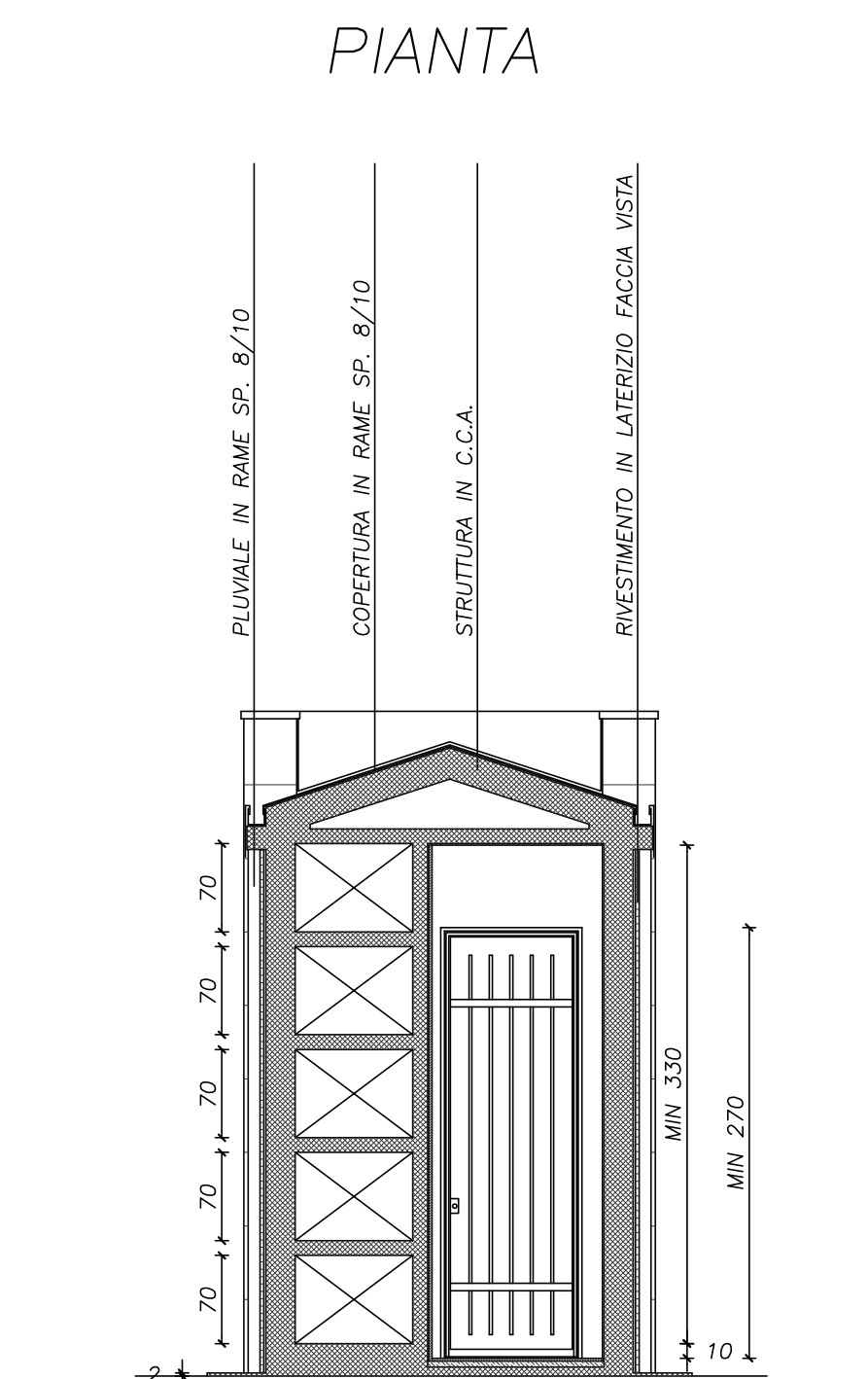
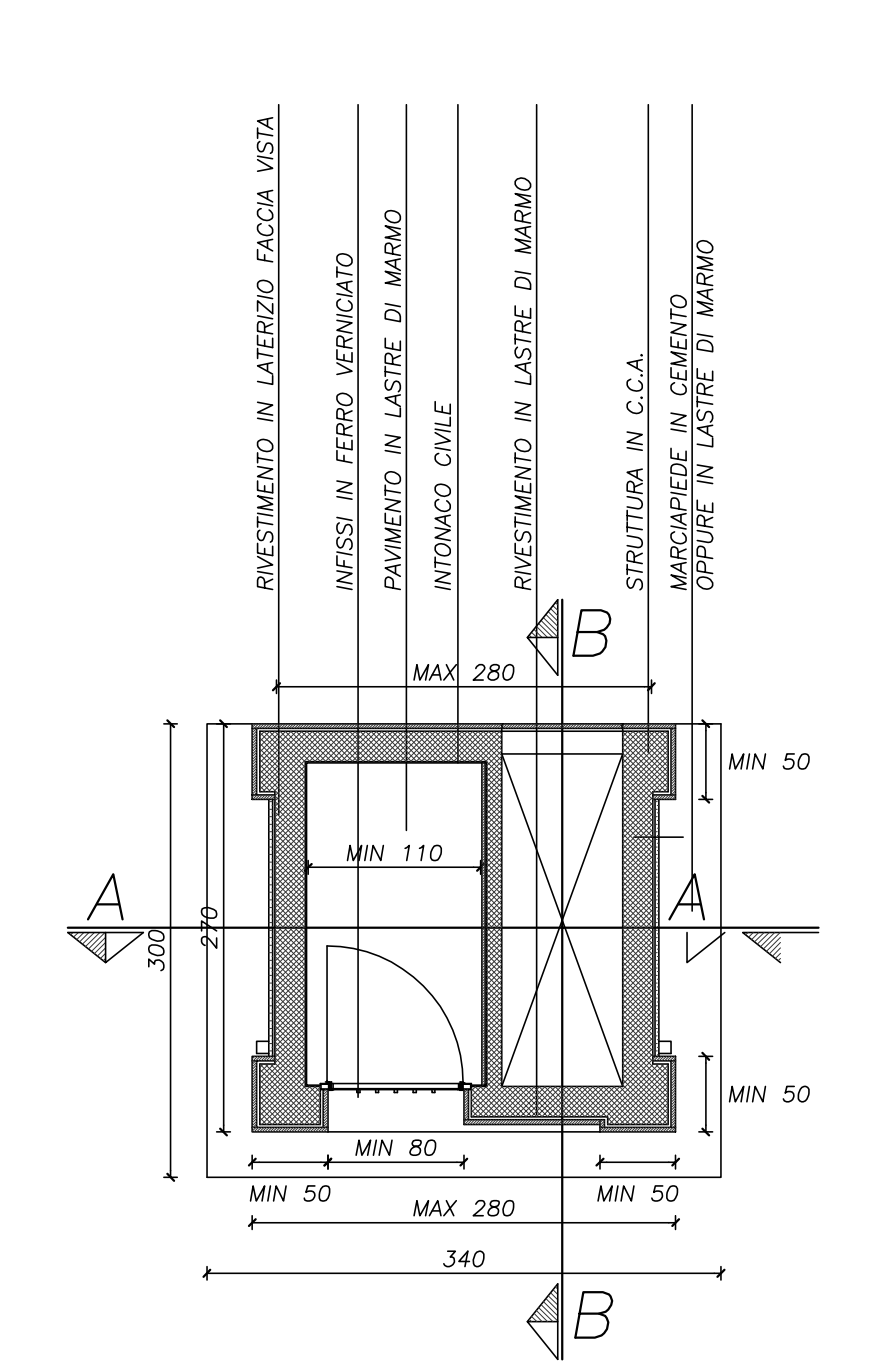

- LEGENDA:
- C.C.A.
 - LASTRE DI MARMO
 - LATERIZIO FACCIA VISTA
 - SOTTOFONDO

SCHEMA DI AGGREGAZIONE – scala 1:100

LOTTE PER EDICOLE FUNERARIE:
 TIPO A – cm.430X350 (CON MARCIAPIEDE ESTERNO cm.490X380)
 TIPO B – cm.280X270 (CON MARCIAPIEDE ESTERNO cm.340X300)
 (16 – NUMERO LOTTO)

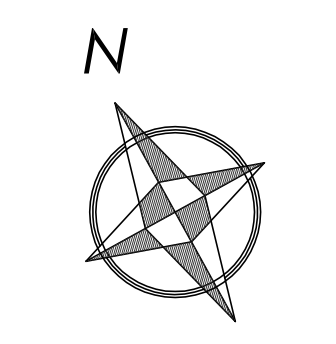
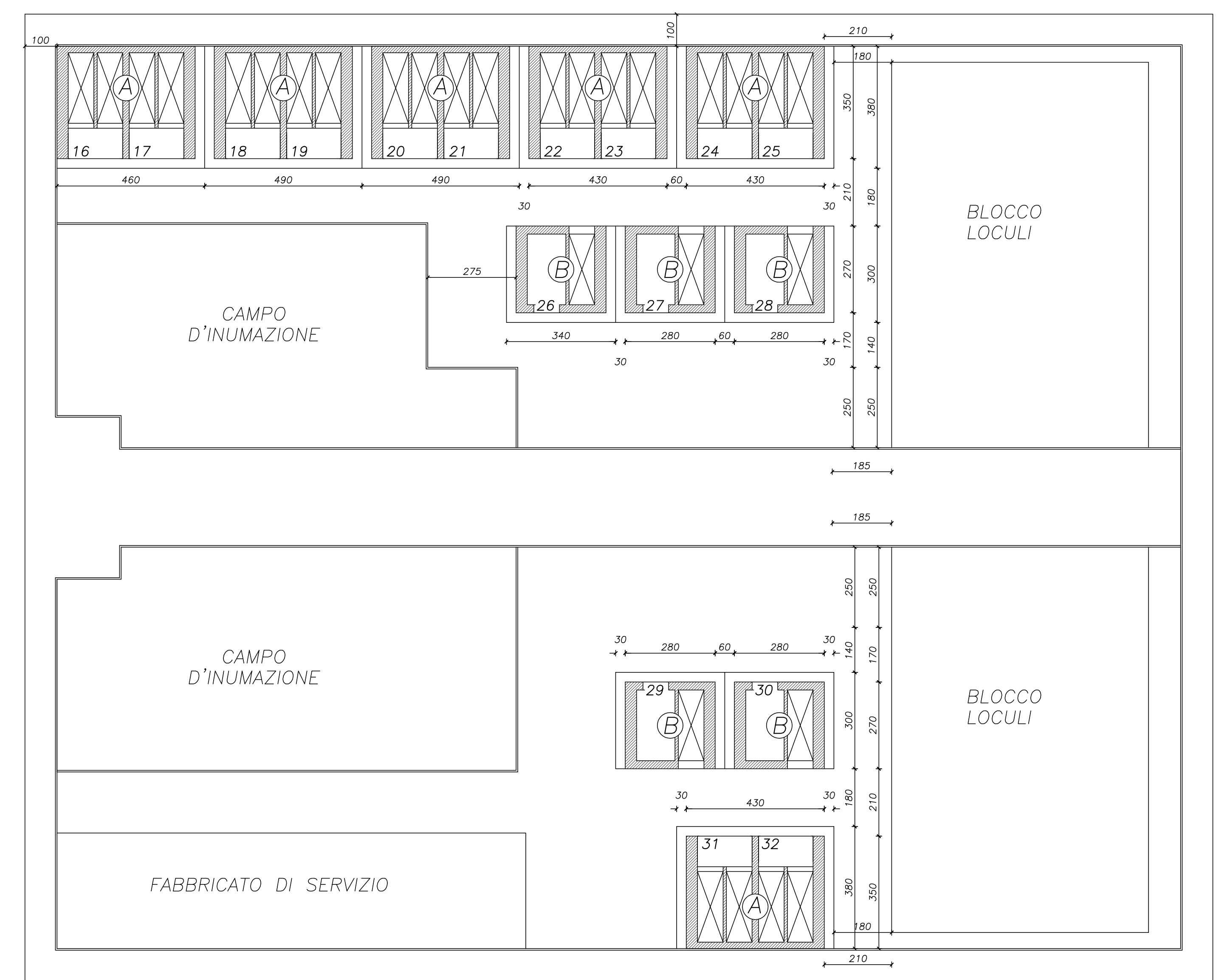

Allegato 3.2

COMUNE DI FORLÌ

SINDACO Roberto Bolzani	SEGRETARIO GENERALE Antonio Ventrella	ASSESSORE QUALITÀ AMBIENTALE Alberto Bellini
AREA PIANIFICAZIONE E SVILUPPO DEL TERRITORIO DIRETTORE AREA Massimo Vadrucchi (Responsabile del Progetto)		
SERVIZIO PIANIFICAZIONE E PROGRAMMAZIONE DEL TERRITORIO DIRIGENTE Ercolè Conestri		
UNITÀ PIANIFICAZIONE URBANISTICA RESPONSABILE Moro Rubino STAFF OPERATIVO Emma Gallo Mirco Mignoli Lorenza Mionocchi Antonella Simoncelli Valeria Zoli	UNITÀ GESTIONE DEI SERVIZI CIMITERIALI RESPONSABILE Mario Cristiano Loghi	

2009

PIANO REGOLATORE DELLE STRUTTURE CIMITERIALI COMUNALI

(ai sensi del DPR 285/1990 Regolamento di Polizia Mortuaria e della L. R. 19/2004)

CIMITERO COMUNALE DI CASEMURATE

DISCIPLINA EDIFICATORIA DELLE EDICOLE FUNERARIE TIPI E MODALITÀ DI AGGREGAZIONE

SCALA 1:50

APPROVAZIONE	
DELIBERA DI C.C.	
n°	del