

INGRESSO EDICOLA
ACCESSO LOCULO

LEGENDA:

- C.C.A.
- LASTRE DI MARMO
- LATERIZIO FACCIA VISTA
- SOTTOFONDO

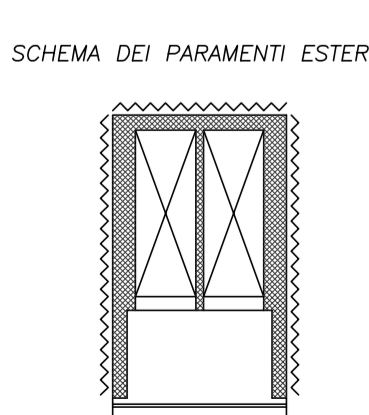

SCHEMA DEI PARAMENTI ESTERNI
C.C.A. A VISTA
LASTRE DI MARMO

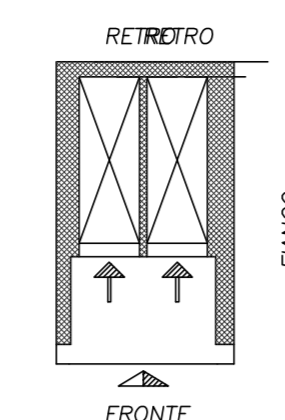
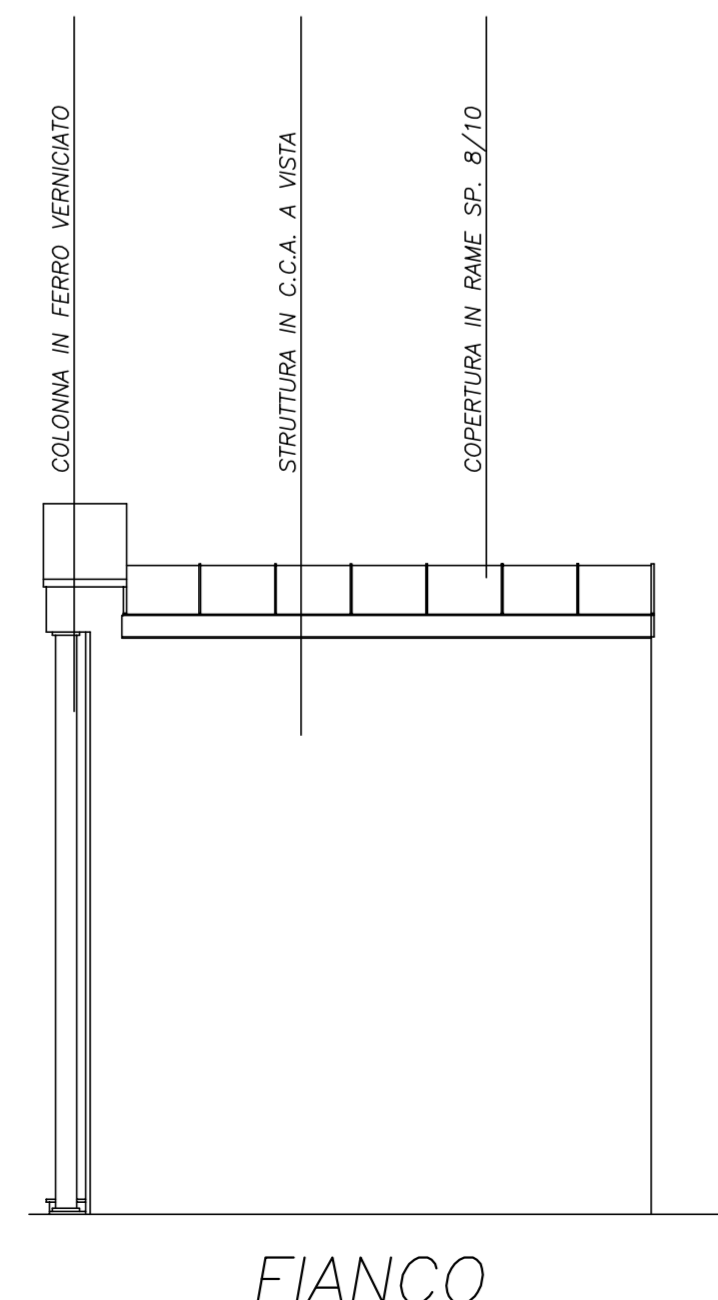
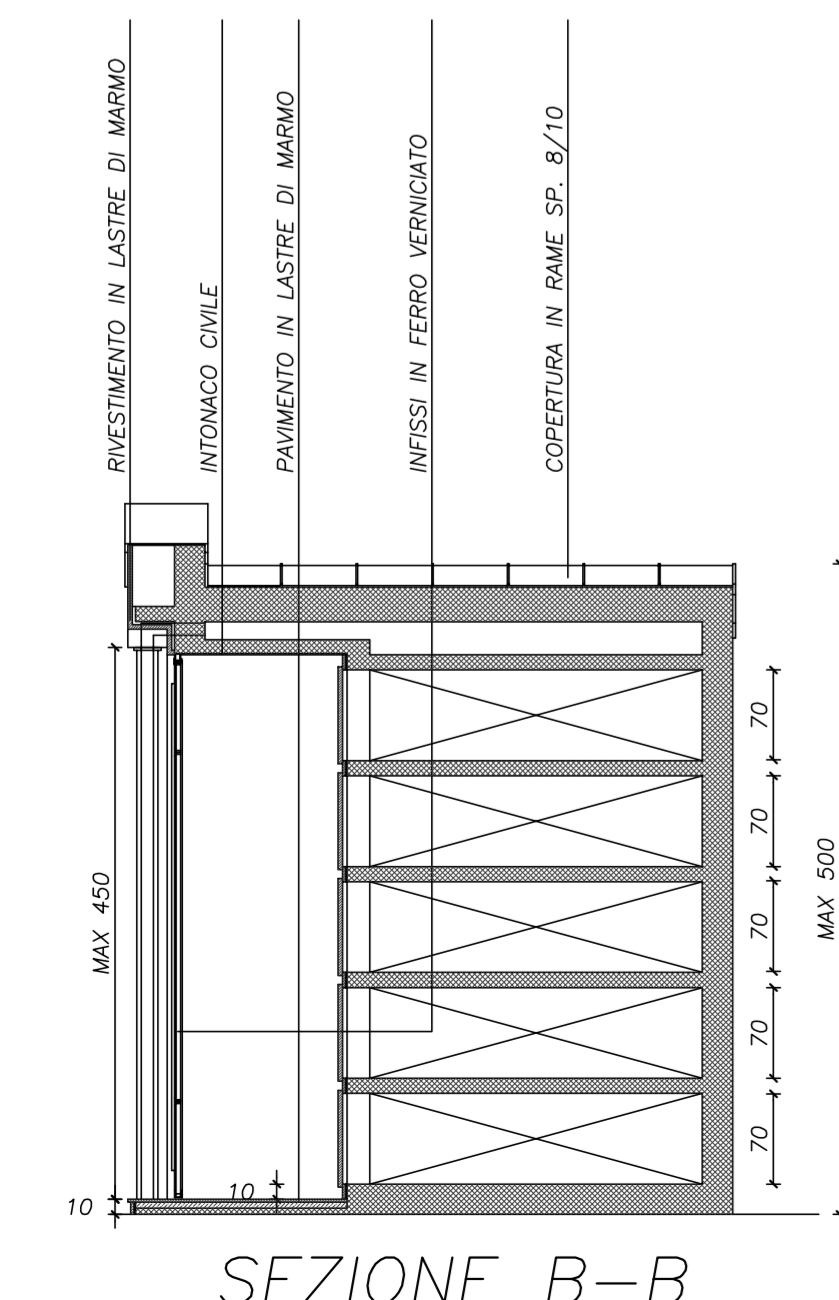
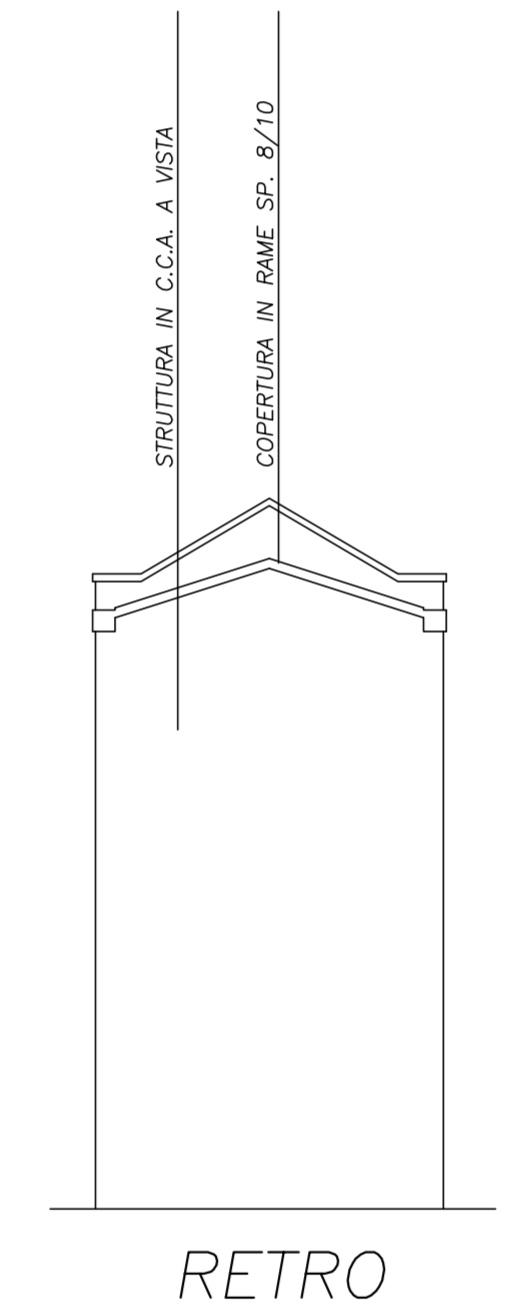
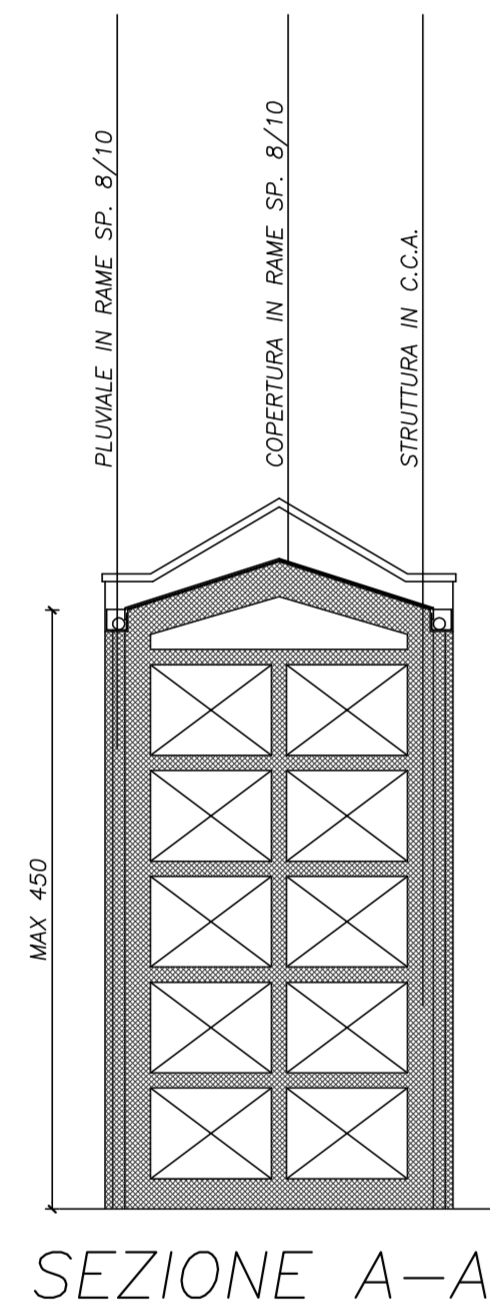
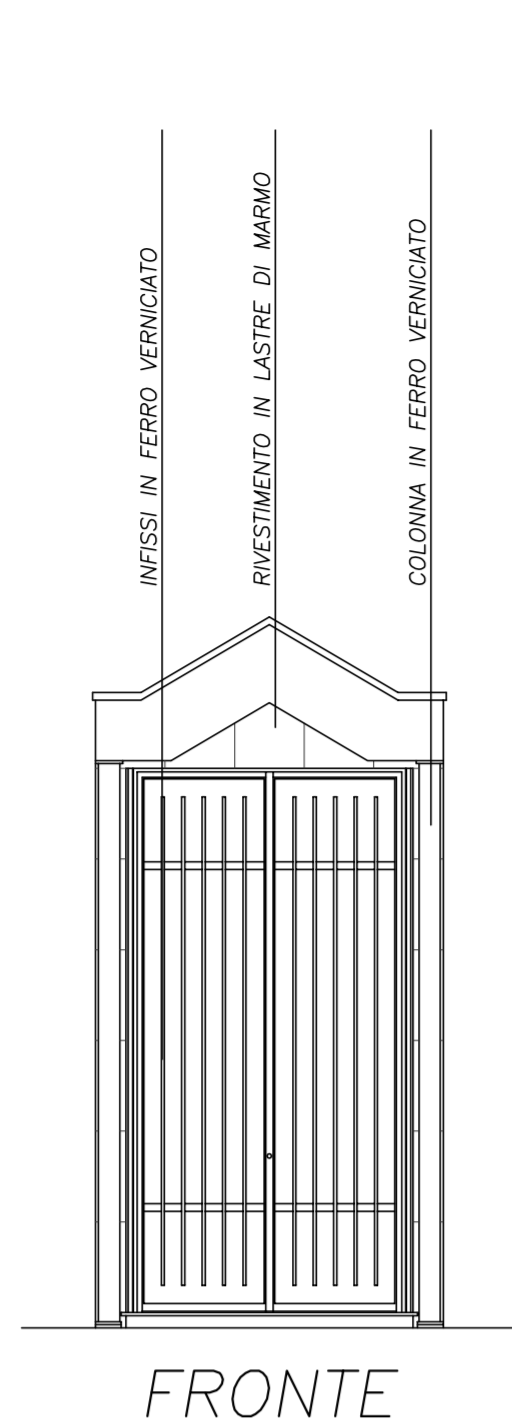
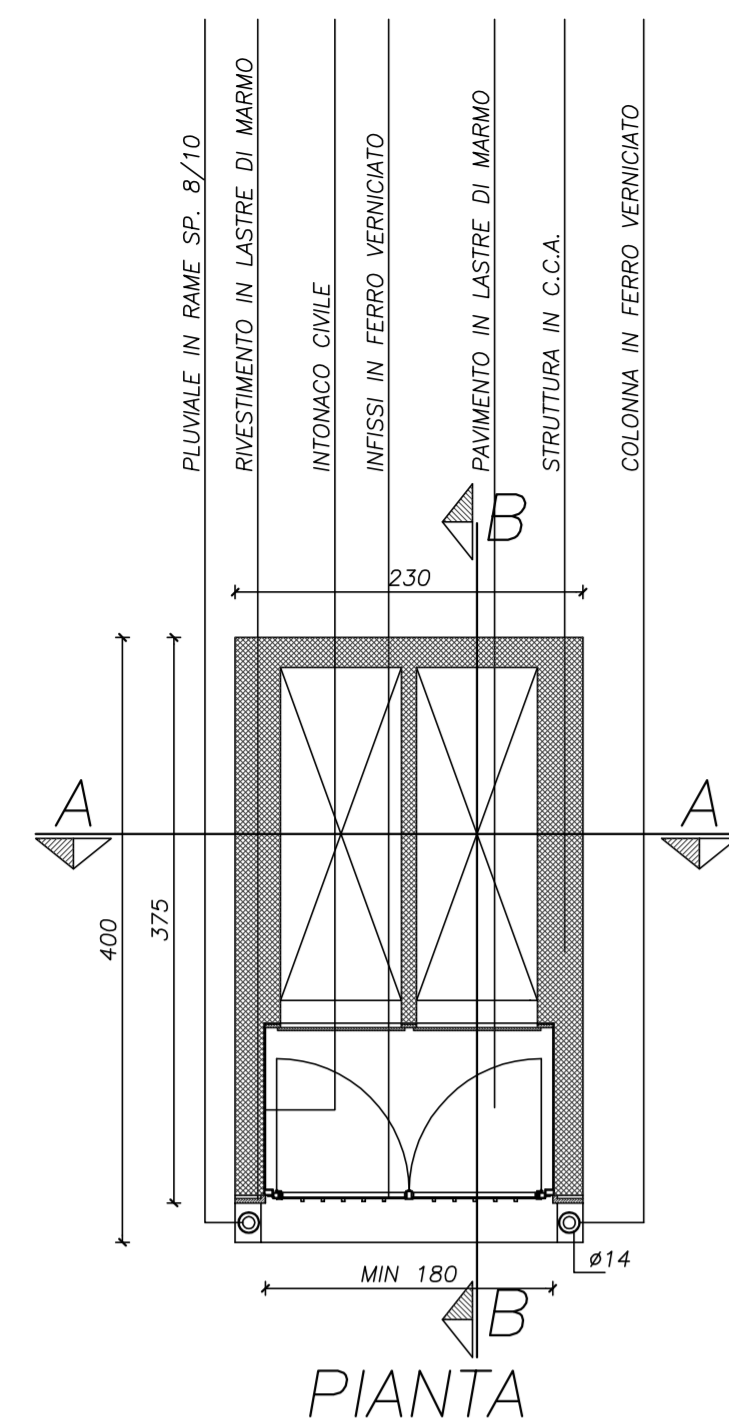

INGRESSO EDICOLA
ACCESSO LOCULO

LEGENDA:

- C.C.A.
- LASTRE DI MARMO
- LATERIZIO FACCIA VISTA
- SOTTOFONDO

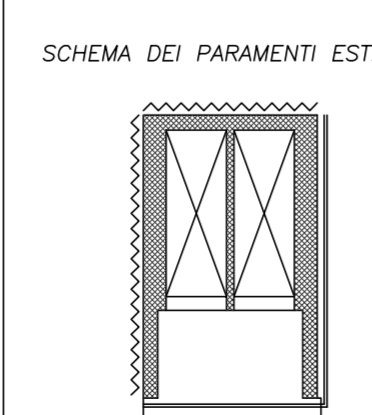

SCHEMA DEI PARAMENTI ESTERNI
C.C.A. A VISTA
LASTRE DI MARMO

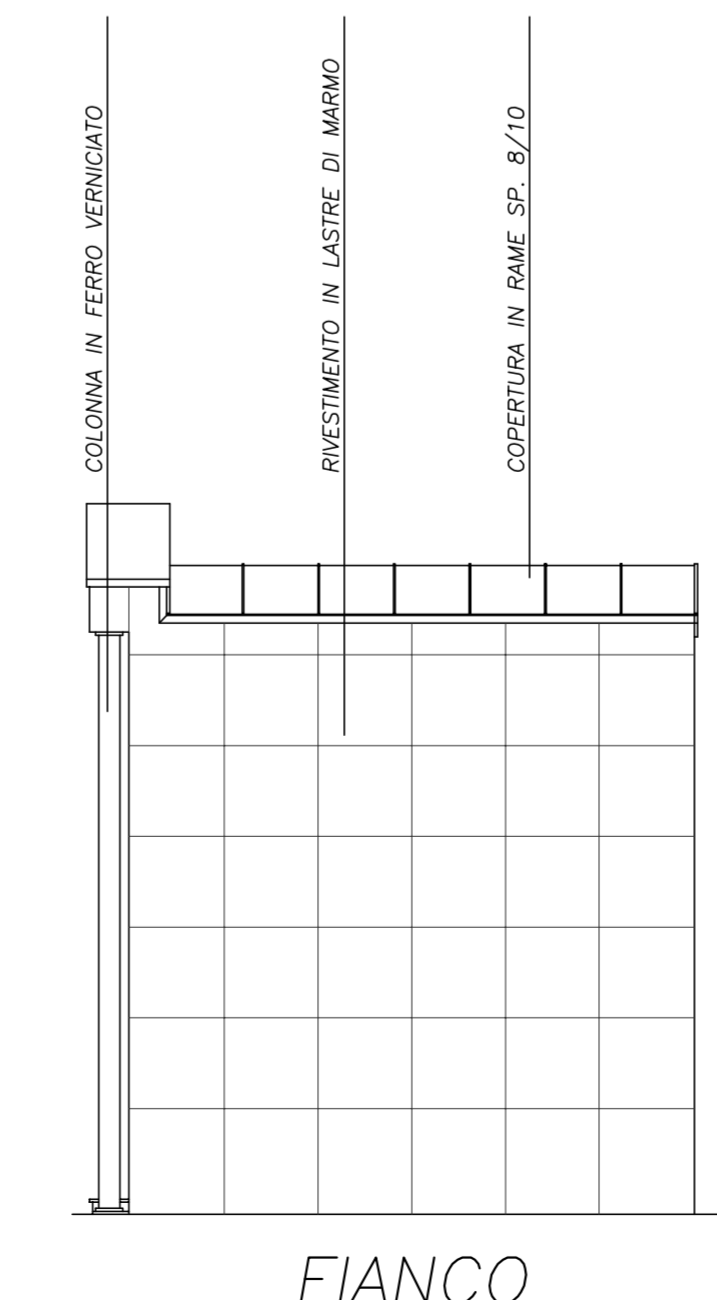
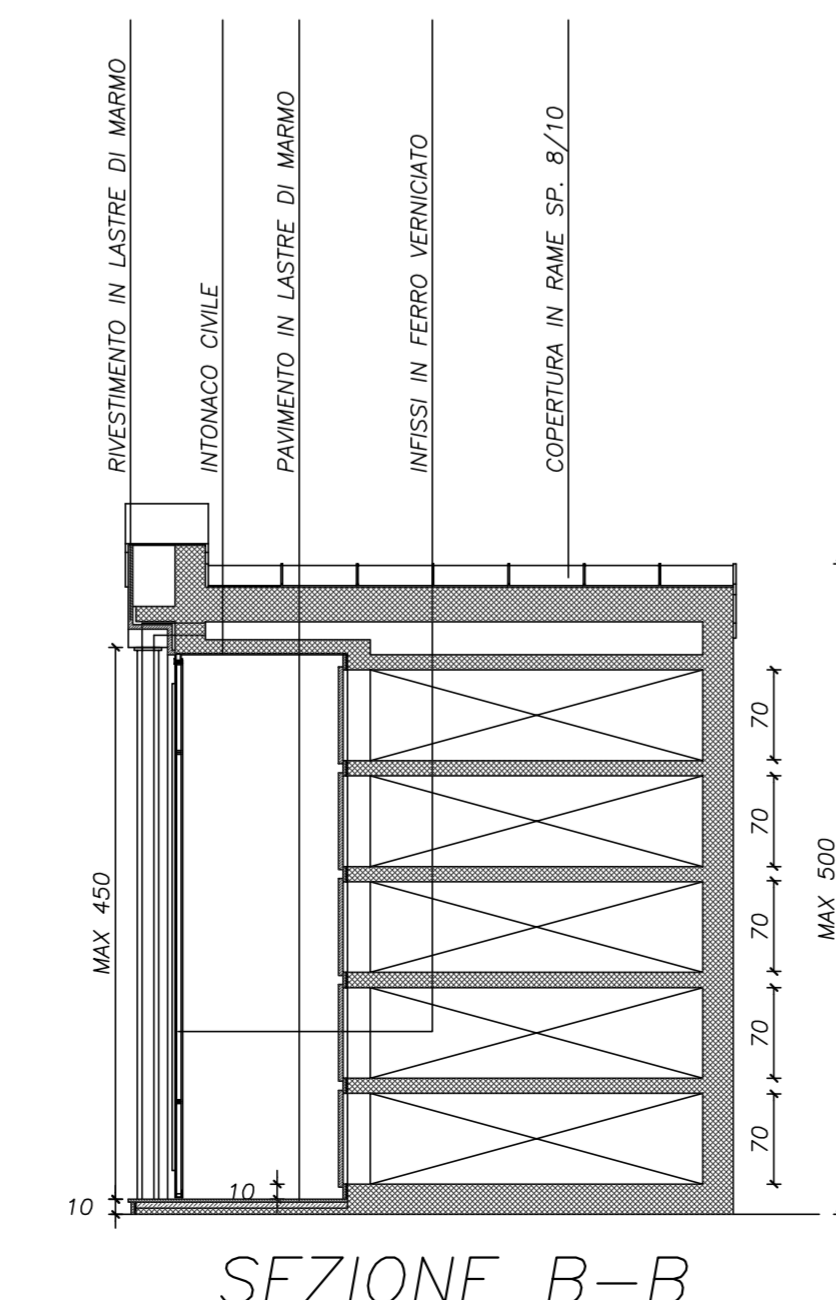
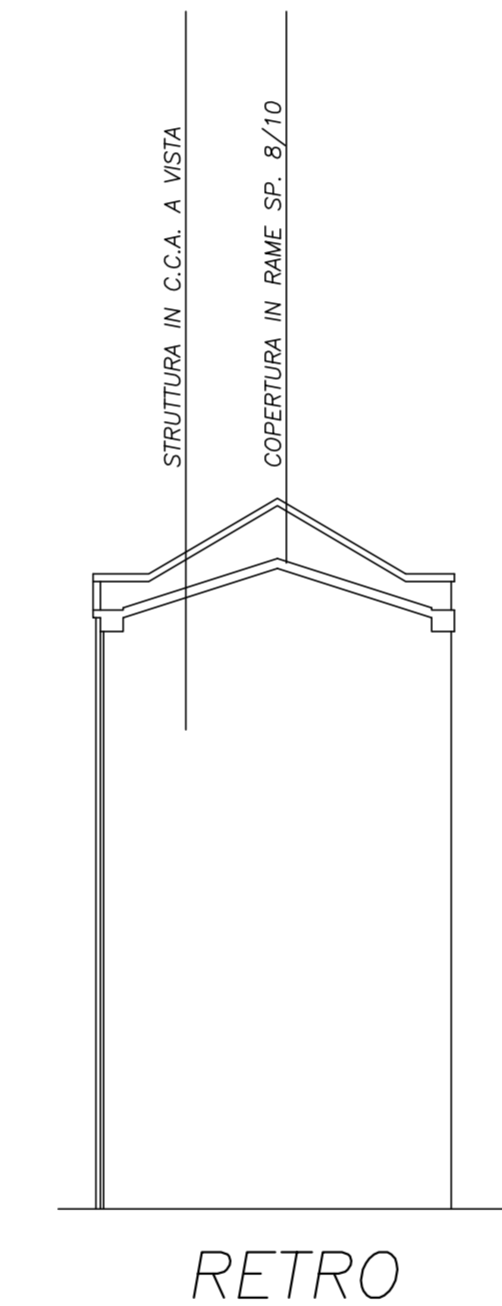
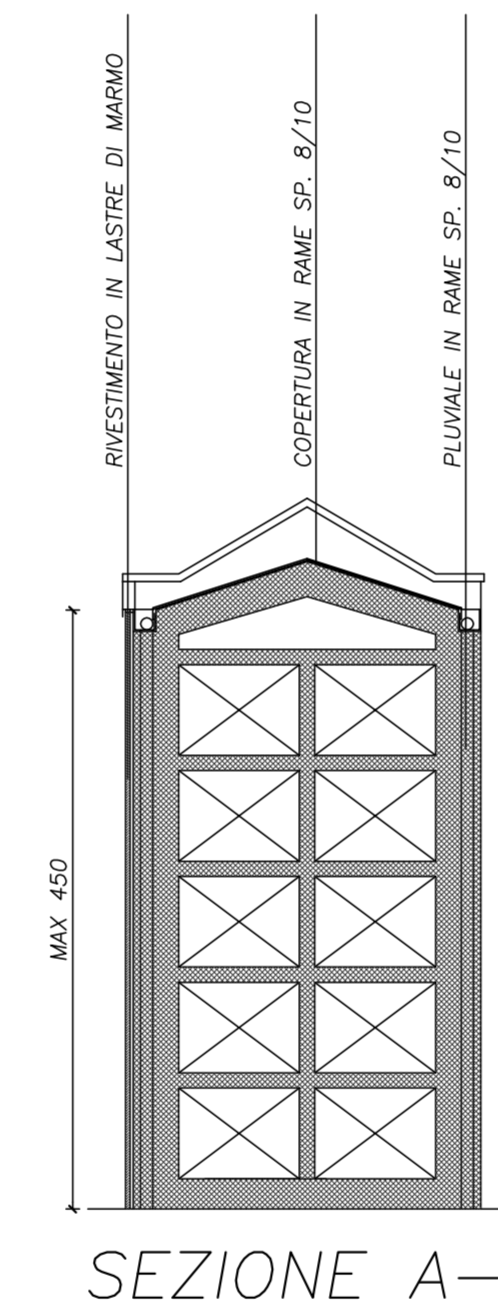
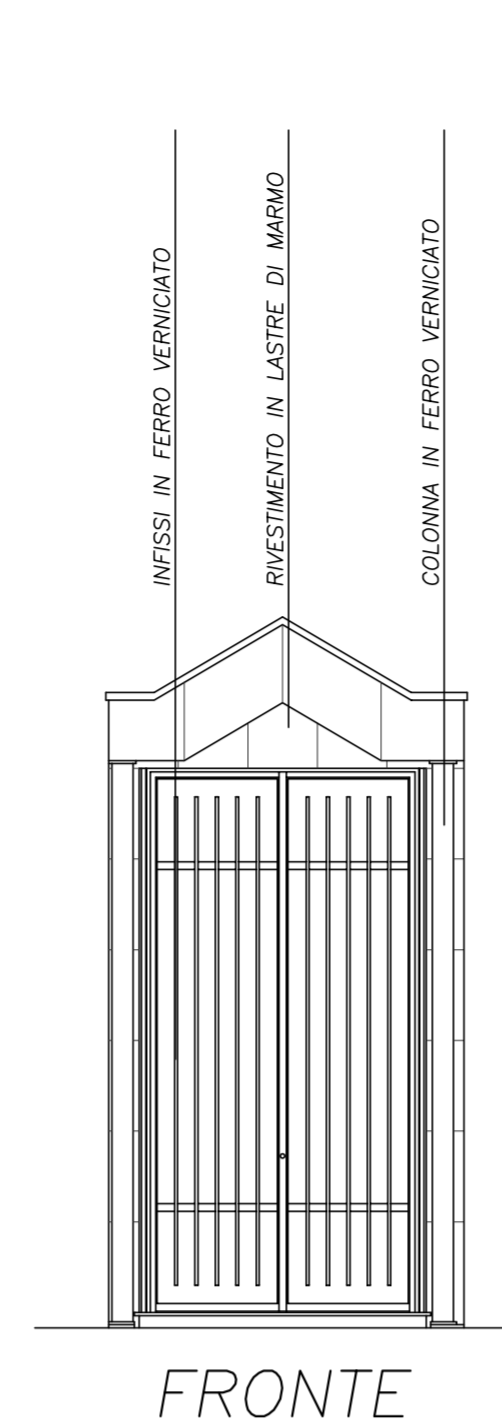
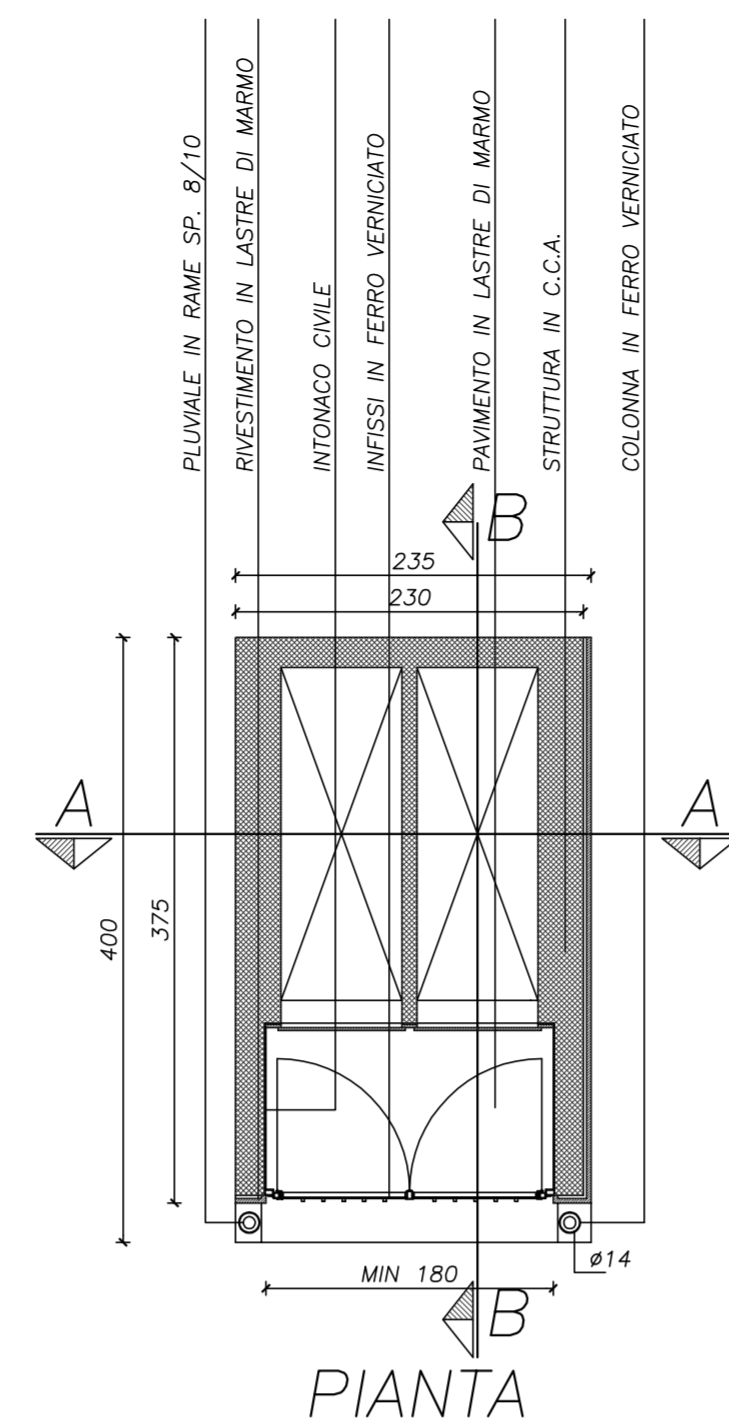

SCHEMA DI AGGREGAZIONE – scala 1:100

LOTTE PER EDICOLE FUNERARIE:

TIPO A– cm.230X375 (CON MARCIAPIEDE ESTERNO cm.230X400 – GIUNTO cm.10)

TIPO B– cm.235X375 (CON MARCIAPIEDE ESTERNO cm.235X400 – GIUNTO cm.10)

(26 – NUMERO LOTTO)

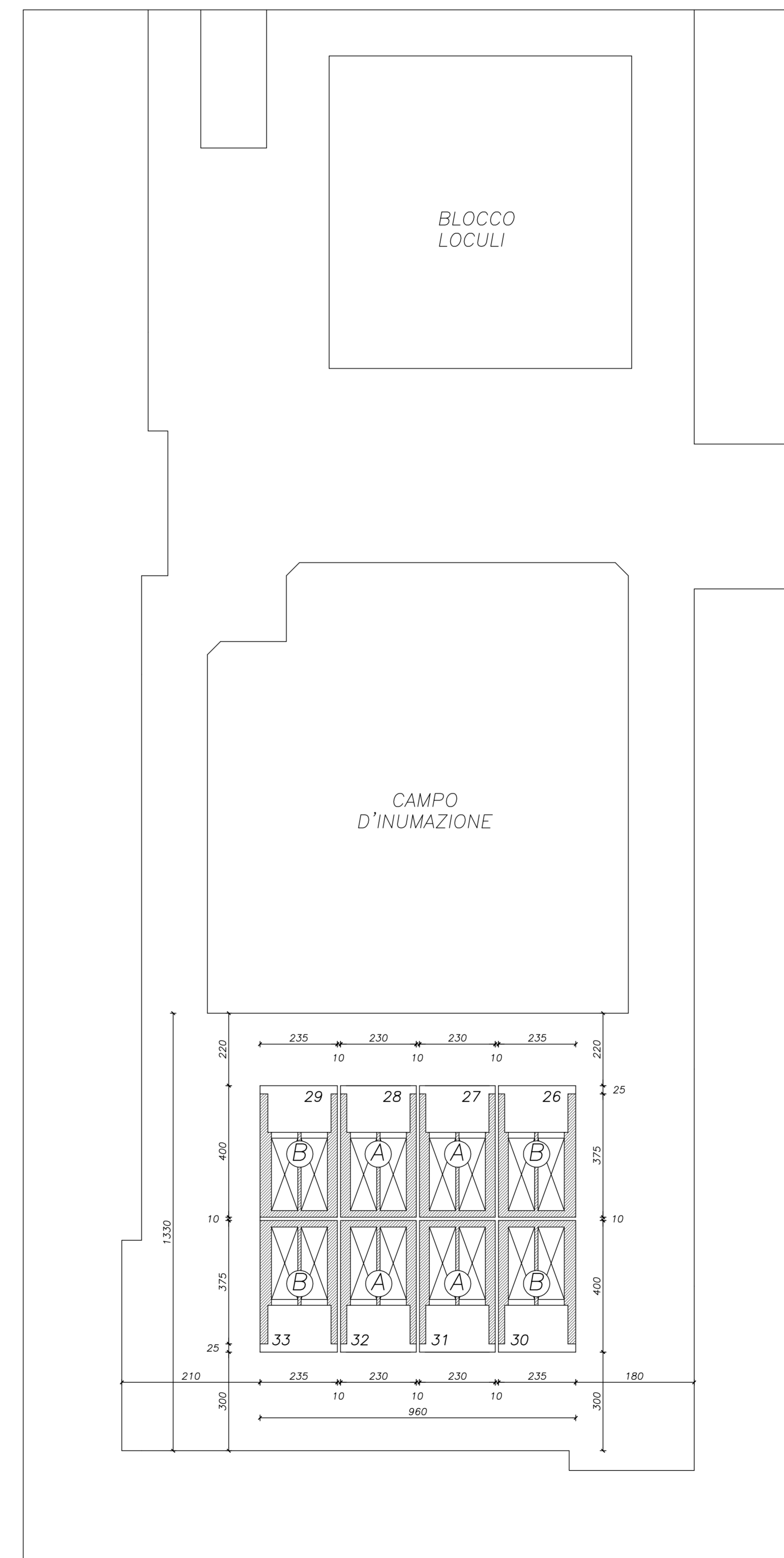



COMUNE DI FORLÌ

SINDACO: Roberto Baloni
 SEGRETARIO GENERALE: Antonio Vietrella
 ASSESSORE QUALITÀ AMBIENTALE: Alberto Belli

AREA PIANIFICAZIONE E SVILUPPO DEL TERRITORIO
 DIRETTORE AREA: Massimo Vidoni (Responsabile del Progetto)
 SERVIZIO PIANIFICAZIONE E PROGRAMMAZIONE DEL TERRITORIO
 DIRIGENTE: Ercole Costantini

UNITÀ PIANIFICAZIONE URBANISTICA RESPONSABILE: Mara Rubinio
 STAFF OPERATIVO: Ermes Colari, Mirco Minardi, Lorenza Misoccheri, Antonella Spioncelli, Valerio Zoli

UNITÀ GESTIONE DEI SERVIZI CIMITERIALI RESPONSABILE: Maria Cristina Loghi



2009

PIANO REGOLATORE DELLE STRUTTURE CIMITERIALI COMUNALI
 (ai sensi del DPR 285/1990 Regolamento di Polizia Mortuaria e della L. R. 19/2004)

CIMITERO COMUNALE DI VILLAGRAPPA
 DISCIPLINA EDIFICATORIA DELLE EDICOLE FUNERARIE
 TIPI E MODALITÀ DI AGGREGAZIONE

APPROVAZIONE
 DELIBERA DI C.C.
 n° del

SCALA 1:50