

TIPO A – EDICOLA FUNERARIA SINGOLA PER UN CONCESSIONARIO CON 10 LOCULI PER CONCESSIONE

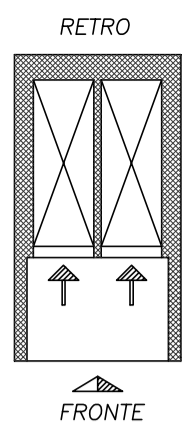

▲ INGRESSO EDICOLA  
 ↑ ACCESSO LOCULO

LEGENDA:

- C.C.A.
- LASTRE DI MARMO
- LATERIZIO FACCIA VISTA
- SOTTOFONDO

SCHEMA DEI PARAMENTI ESTERNI

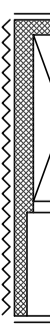

— LATERIZIO FACCIA VISTA  
 ~~~~~ C.C.A. A VISTA

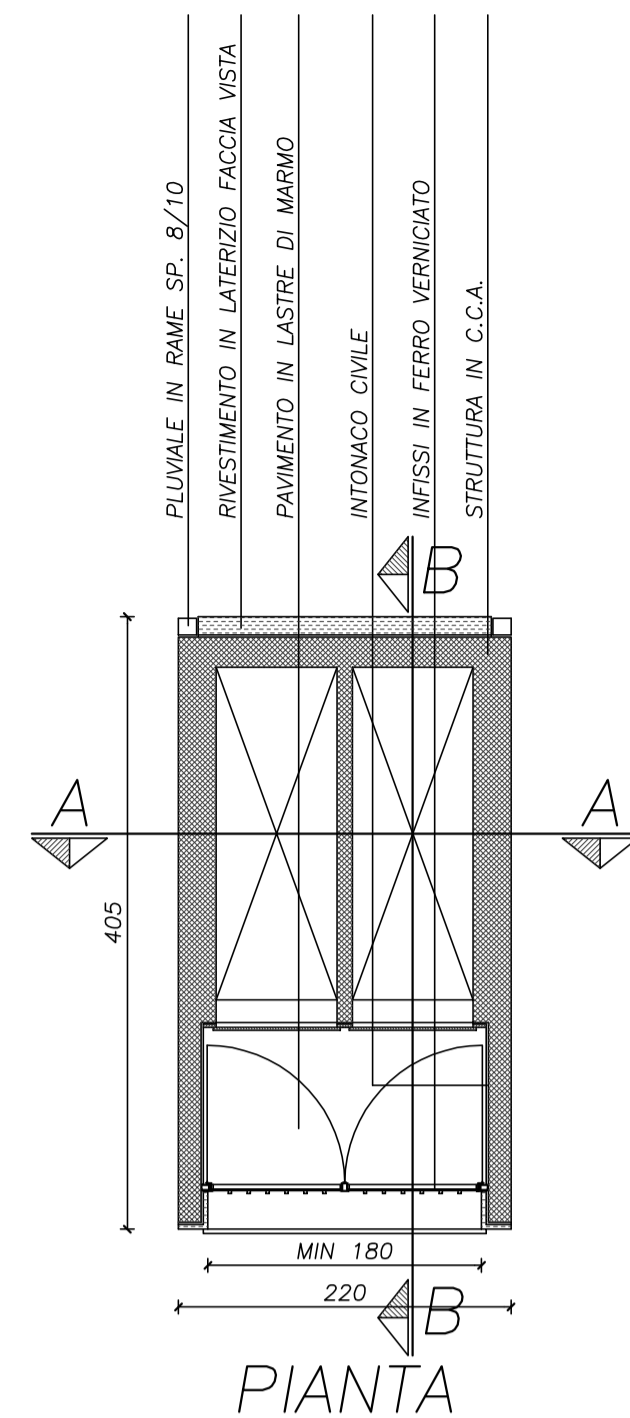

PIANTA

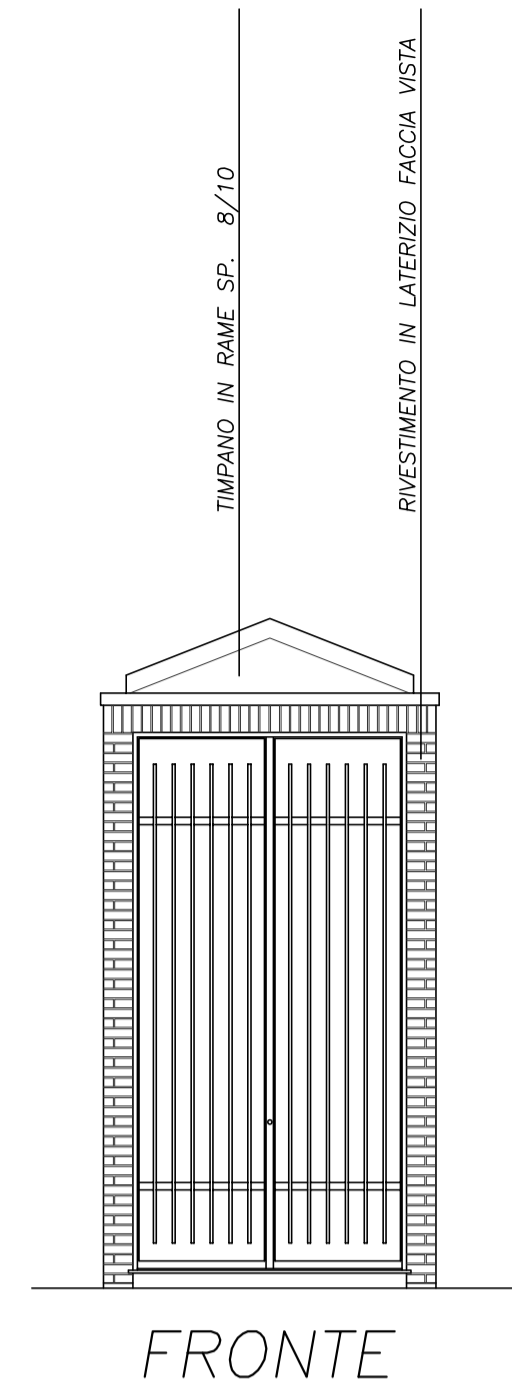

FRONTE

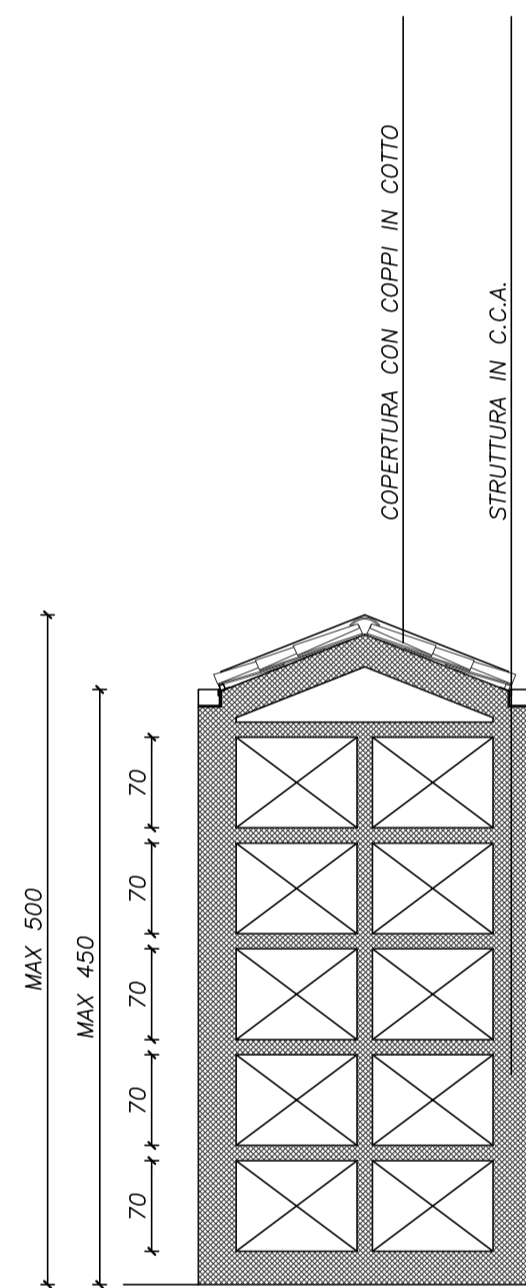

SEZIONE A-A

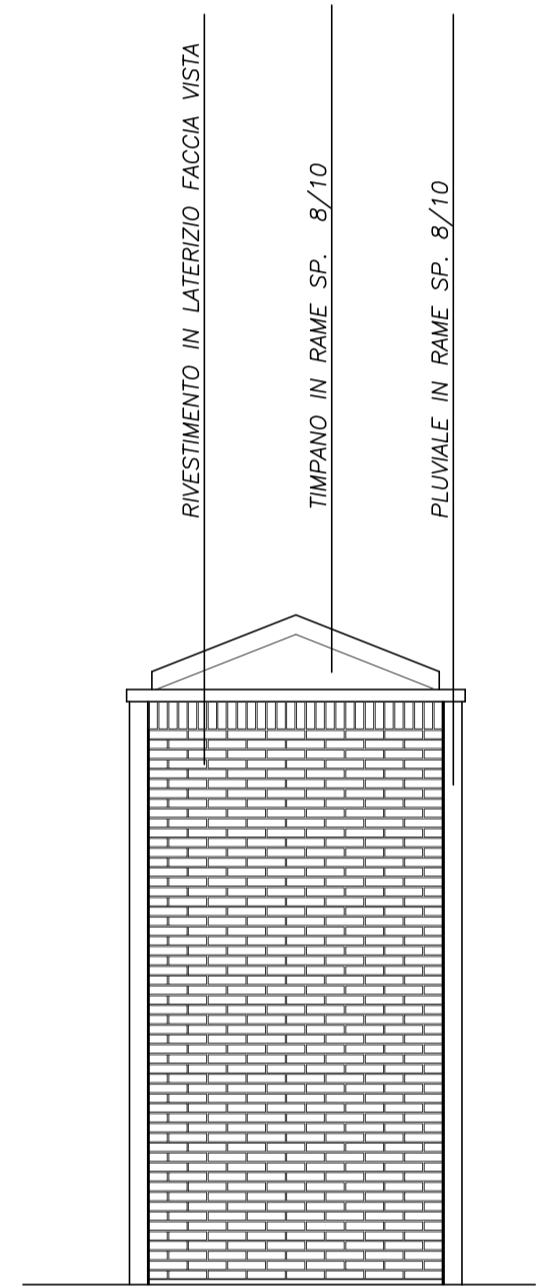

RETRO

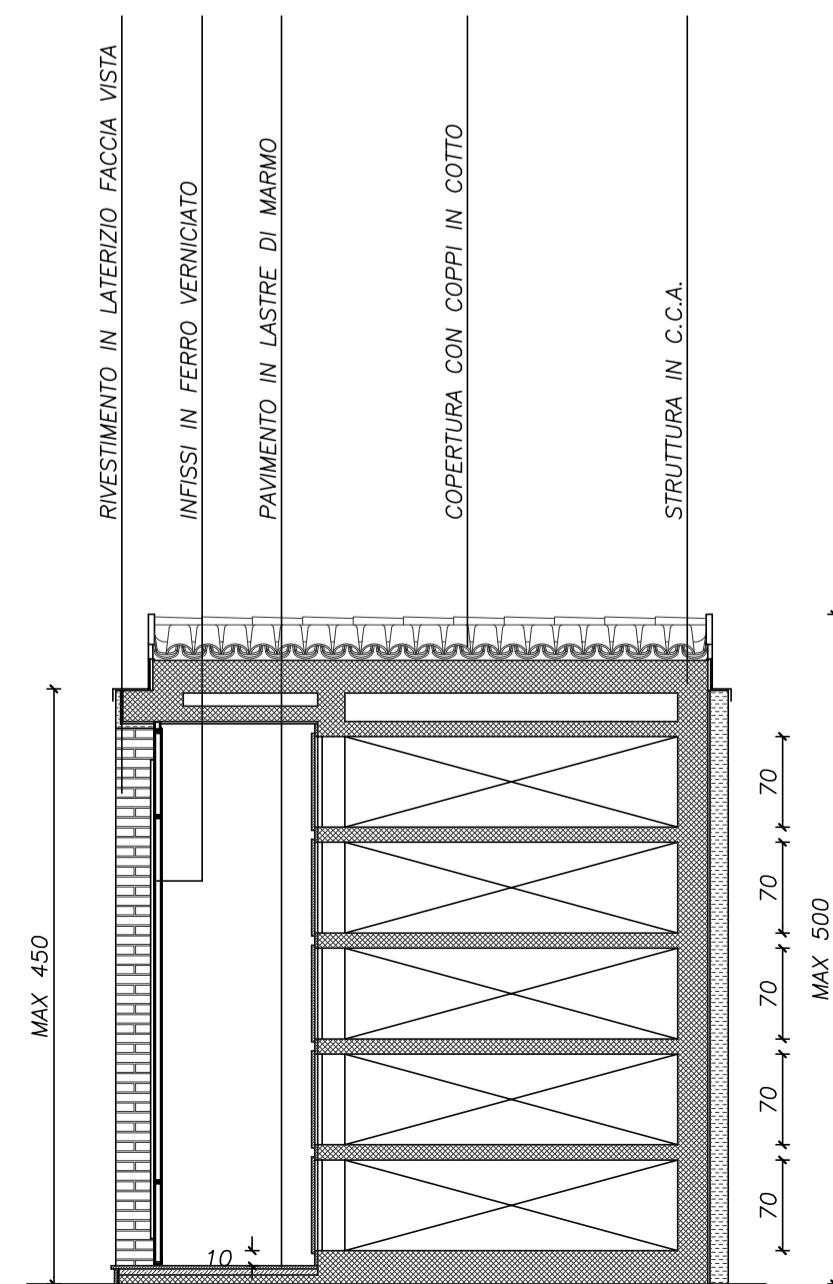

SEZIONE B-B

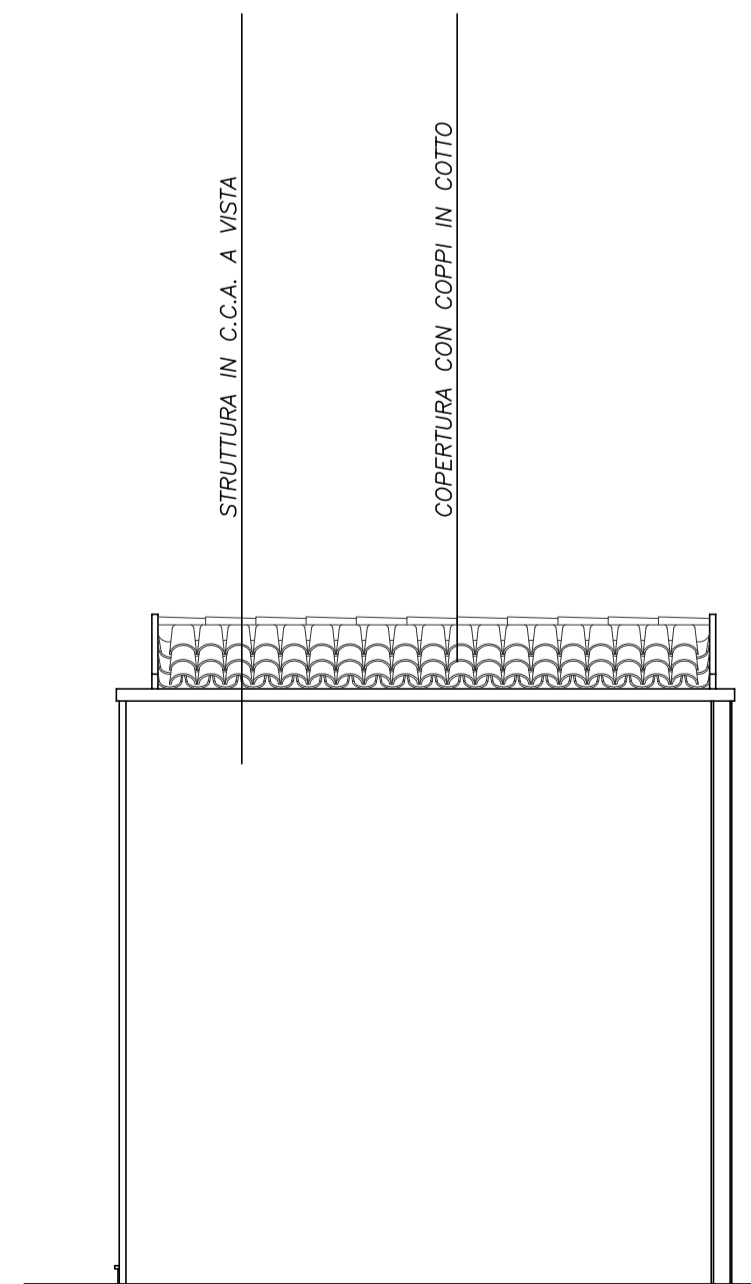

FIANCO

TIPO B – EDICOLA FUNERARIA SINGOLA PER UN CONCESSIONARIO CON 10 LOCULI PER CONCESSIONE

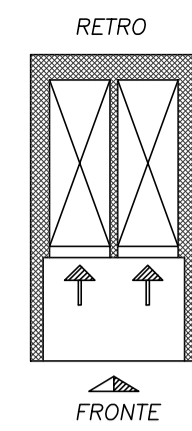

▲ INGRESSO EDICOLA  
 ↑ ACCESSO LOCULO

LEGENDA:

- C.C.A.
- LASTRE DI MARMO
- LATERIZIO FACCIA VISTA
- SOTTOFONDO

SCHEMA DEI PARAMENTI ESTERNI

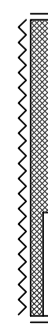

— LATERIZIO FACCIA VISTA  
 ~~~~~ C.C.A. A VISTA

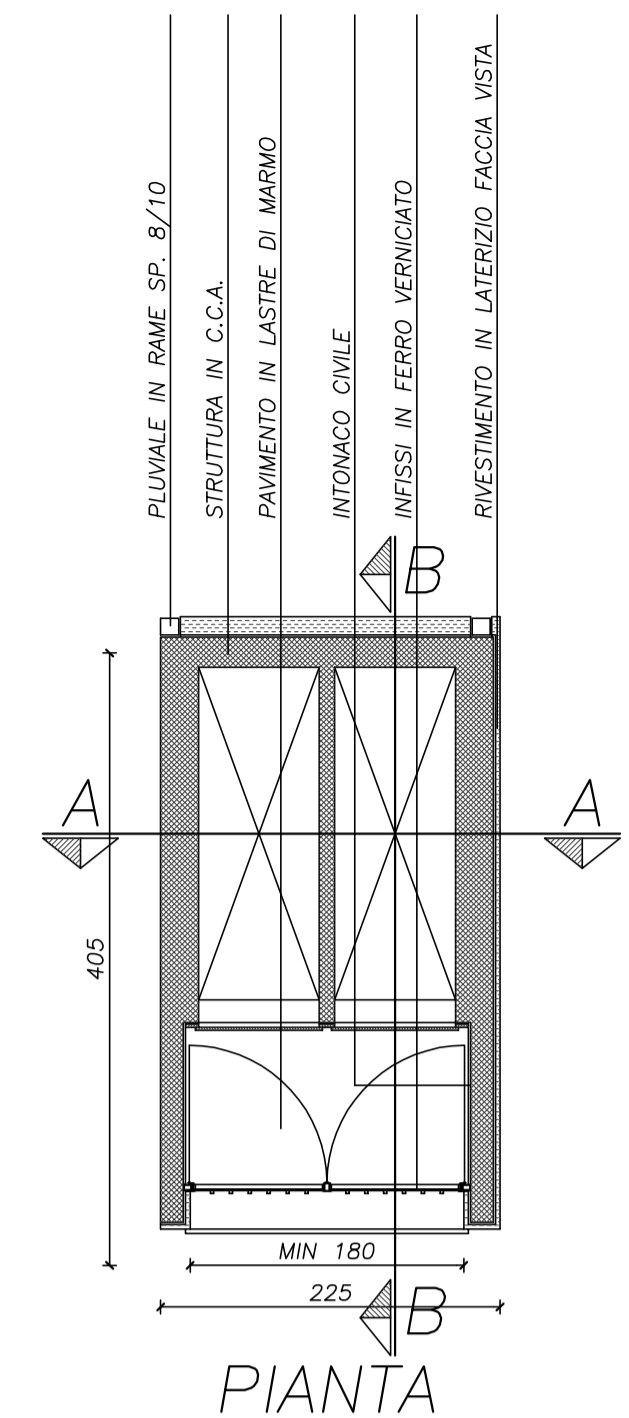

PIANTA

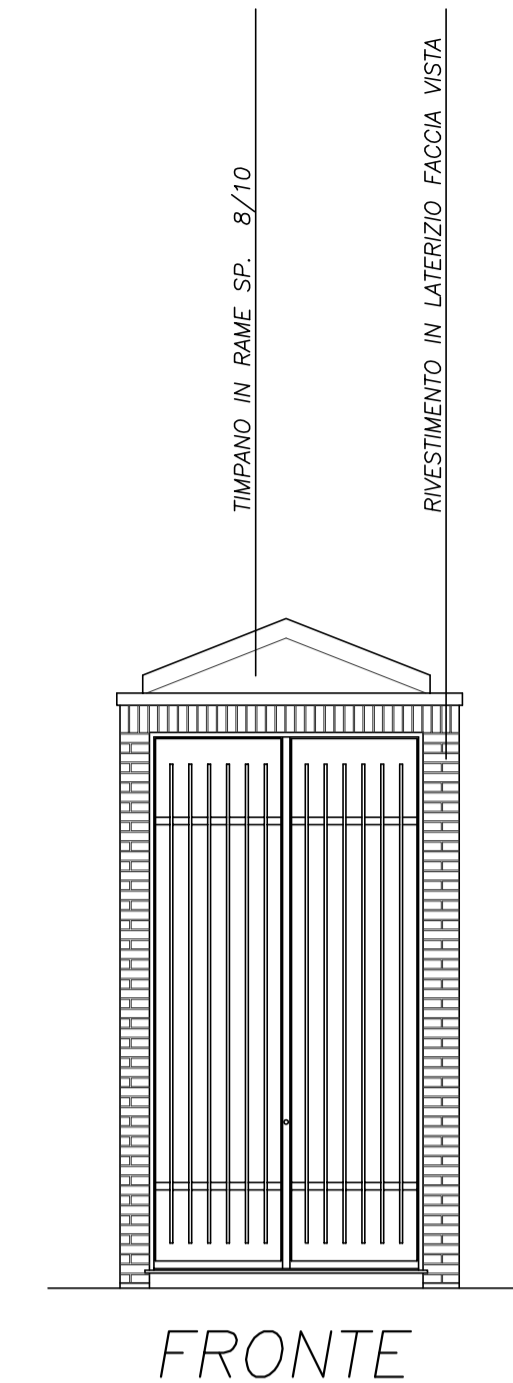

FRONTE

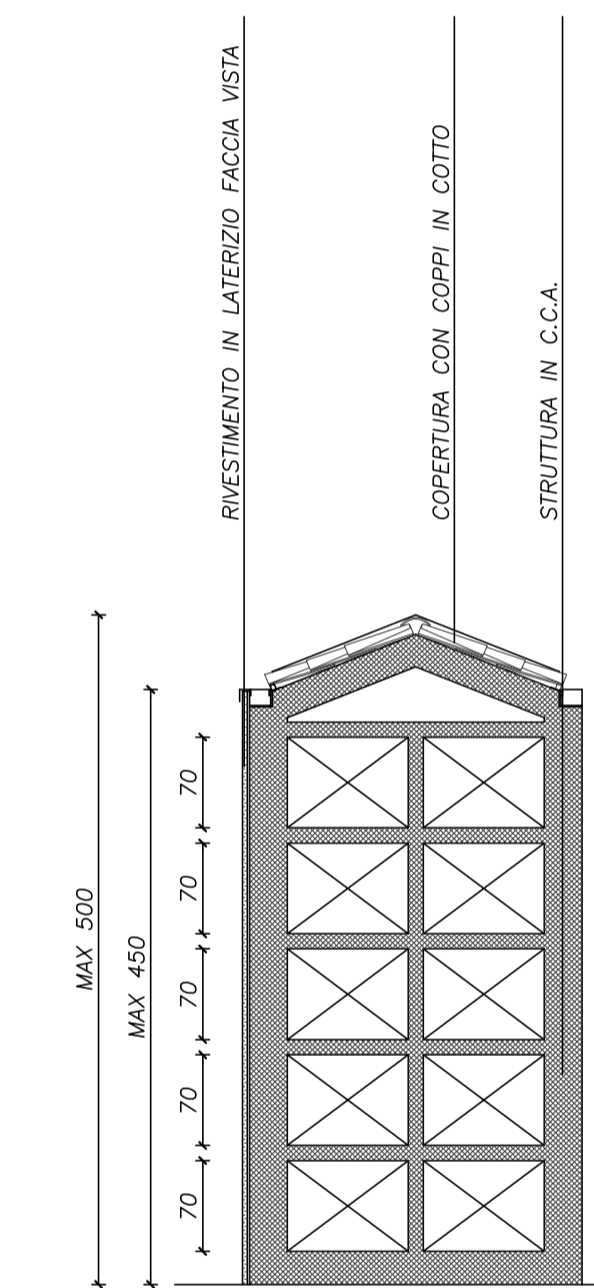

SEZIONE A-A

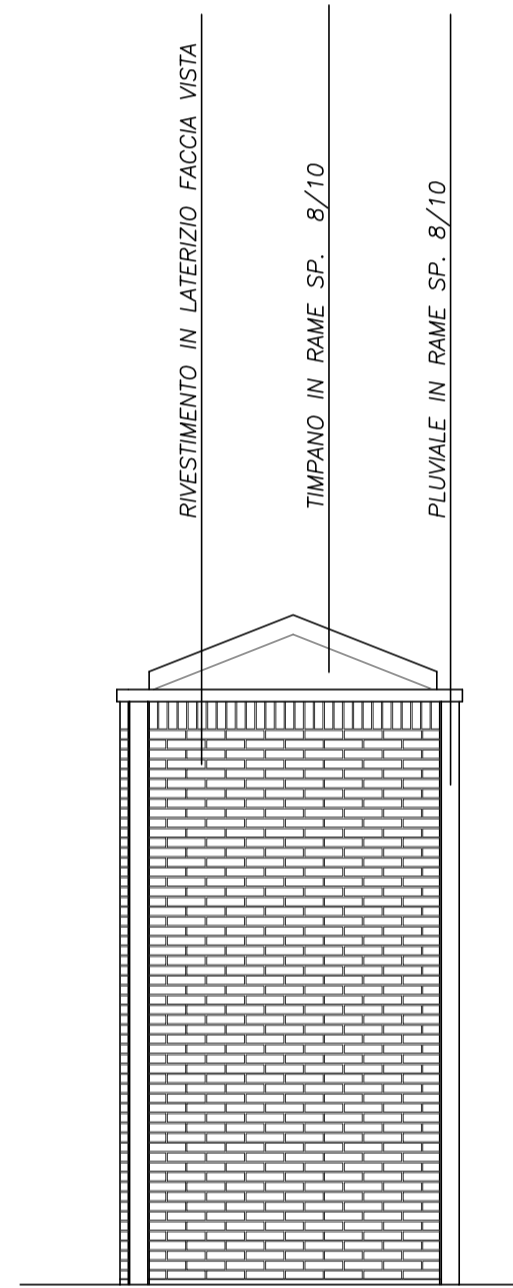

RETRO

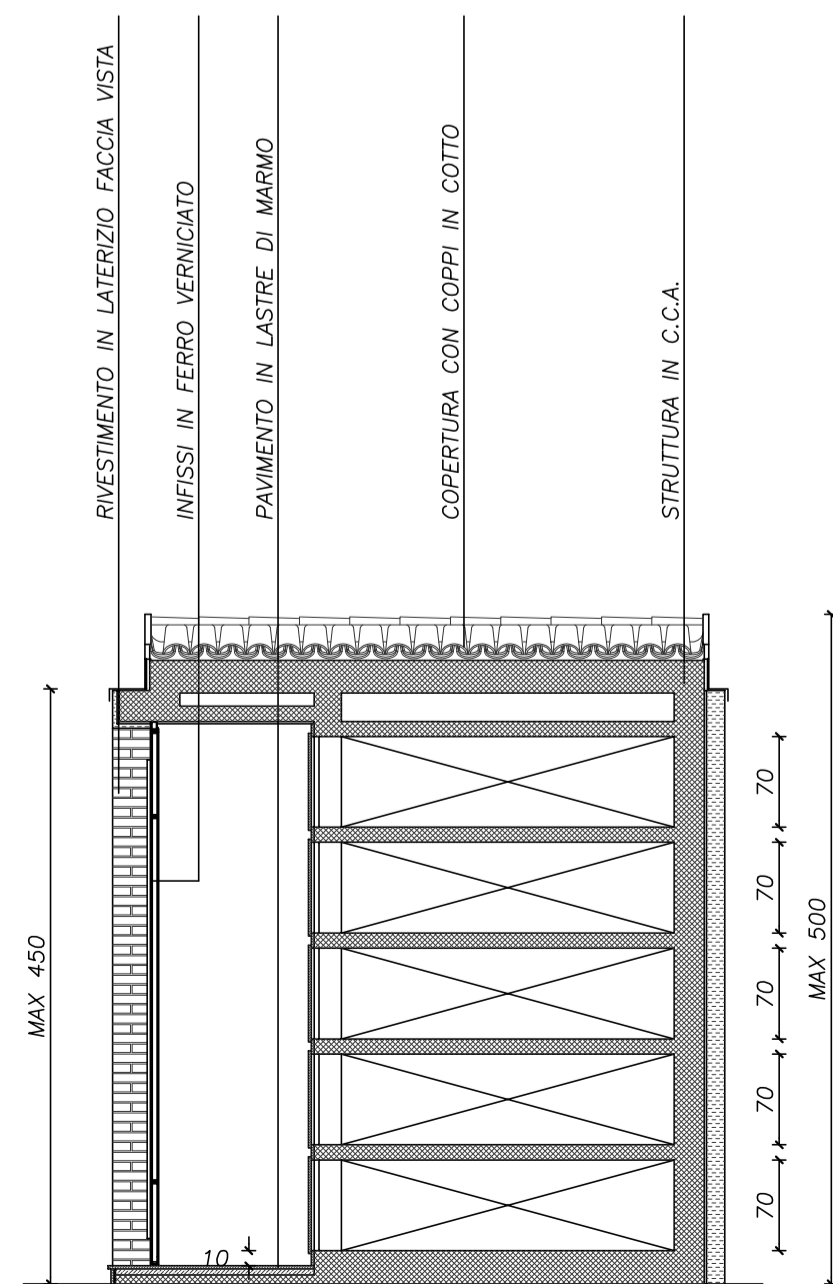

SEZIONE B-B

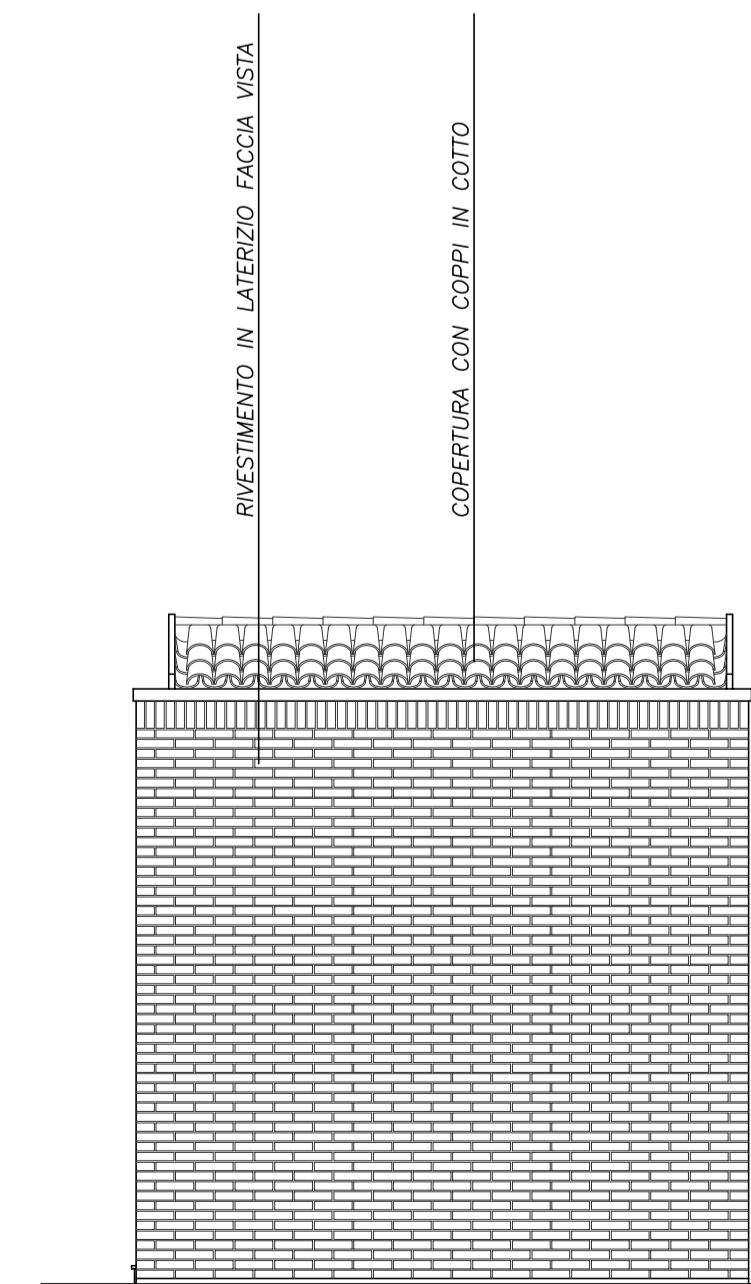

FIANCO

**COMUNE DI FORLÌ**

|   |   |   |
|---|---|---|
| SINDACO<br>Roberto Balzani  | SEGREARIO GENERALE<br>Antonio Ventrella | ASSESSORE QUALITÀ AMBIENTALE<br>Alberto Bellini                                 |
| AREA PIANIFICAZIONE E SVILUPPO DEL TERRITORIO<br>DIRETTORE AREA<br>Massimo Valdinoi (Responsabile del Progetto) |   |   |
| SERVIZIO PIANIFICAZIONE E PROGRAMMAZIONE DEL TERRITORIO<br>DIRIGENTE<br>Ercole Conestriani                      |   |   |
| UNITA' PIANIFICAZIONE URBANISTICA<br>RESPONSABILE<br>Mara Rubino  |   | UNITA' GESTIONE DEI SERVIZI CIMITERIALI<br>RESPONSABILE<br>Maria Cristina Laghi |

2009

**PIANO REGOLATORE  
 DELLE STRUTTURE CIMITERIALI COMUNALI**  
(ai sensi del DPR 285/1990 Regolamento di Polizia Mortuaria e della L. R. 19/2004)

**CIMITERO COMUNALE DI VECCHIAZZANO**  
**DISCIPLINA EDIFICATORIA DELLE EDICOLE FUNERARIE**  
**TIPI E MODALITÀ DI AGGREGAZIONE**

SCALA 1:50

|                  |     |
|------------------|-----|
| APPROVAZIONE     |     |
| DELIBERA DI C.C. |     |
| n°               | del |